

**INSTRUCTIONS FOR THE USE & CARE
OF YOUR ZANUSSI MICROWAVE
ME1205B**

**INSTRUCTIONS FOR THE USE & CARE
OF YOUR ZANUSSI MICROWAVE
ME1205W**



It is most important that this instruction book should be retained with the appliance for future reference. Should the appliance be sold or transferred to another owner, or should you move house and leave the appliance, always ensure that book is supplied with the appliance so that the new owner can be acquainted with the functioning of the appliance and the relevant warnings.

Warnings

THESE WARNINGS ARE PROVIDED IN THE INTEREST OF SAFETY. YOU MUST READ THEM CAREFULLY BEFORE INSTALLING OR USING THE APPLIANCE.

- Do not use this appliance for any other purpose than the preparation of normal domestic food. Take care to read the instructions regarding loads and timings. Also the recommendations/advice on suitable containers and utensils (see cookery book).

- The oven must not be operated when empty as this could damage the oven.

Do not operate the oven if it is damaged until it has been repaired by a service technician trained by the manufacturer. It is particularly important that the oven door closes properly and that there is no damage to:

(1) Door (warped), (2) Hinges and Latches (broken or loosened), (3) Door Seals and Sealing Surfaces (broken or cracked).

- Always keep the door seal and door surfaces clean by wiping regularly with a damp cloth, so that any grease, soil or spatters are not allowed to build up. Such build up could result in leakage of microwave energy from the oven.

- This appliance is designed to be operated by adults. Children should not be allowed to tamper with the controls or play with the product.

- Any electrical work required to install this appliance should be carried out by a qualified person.

- This product should be serviced by an authorised Zanussi Network Service Centre, and only genuine Zanussi spare parts should be used.

- It is dangerous to alter the specifications or modify the product in any way.

- DO NOT overcook foods. Overcooking certain foods can result in dehydration and subsequently fire. Jacket potatoes and foods with a high sugar content – such as those containing dried fruits – are particularly vulnerable. In case of fire unplug the oven and do not open the door.

- Care and cleaning of the appliance are important. Food deposits should not be left on the interior cabinet. Do not place any object between the oven front face and the door, or allow the door seals to accumulate dirt.

- Always be careful when removing protective film from food after cooking as the steam when released can cause burns.

- Any foodstuffs with a 'skin', e.g. potatoes, sausages etc, must be pierced in order to allow for the release of steam.

- Under no circumstances should live animals be placed in a microwave.

- Unplug the appliance if it is to be left for a period of time, e.g. during holidays or long weekends.

- Bases of cooking vessels get very hot. Care should be

taken that the dish does not come into contact with any plastic surface. Wear protective gloves.

- Care should be taken when using microwave browning dishes on the glass tray as the bases become exceedingly hot and may cause the tray to shatter (See browning dish manufacturers' instructions on timings and use).

- Be cautious when eating food direct from the microwave as items with a high sugar or fat content can be very hot inside.

- Airflow above, below and at the sides of a microwave should not be restricted. See installation instructions.

- Only use cooking containers recommended for use in a microwave.

- Do not use metal containers, metal glazed china, melamin or cut glass as cooking containers, or bags with metal ties.

- Do not use more than the recommended quantities of aluminium foil in the oven.

- Do not use capped bottles, jars or tins.

- Do not use the oven for drying any items.

- Leave the oven empty at all times when not in use and do not operate the oven when empty.

- Do not let the timer continue to operate after removing the food.

- Do not attempt to cook or reheat eggs in their shells, they may explode. Pierce the skin of egg yolks.

- Do not attempt to deep fat fry in a microwave.

- Do not use this appliance if it is in contact with water.

- Do not reheat drinks in plastic cups, they could melt. Pierce the skin of egg yolks.

- Do not use a conventional meat thermometer. They may be used outside the cooker to check temperatures but not during cooking.

- Do not use the appliance without the glass turntable in position.

- The roller stay is removable and must be correctly positioned with the glass turntable seated on it when cooking.

- Under no circumstances should you attempt to repair the appliance yourself. Repairs carried out by inexperienced persons may cause serious injury. Consult your local Zanussi Network Service Centre. Always insist on genuine Zanussi spare parts.

WARNING: it is dangerous for any person other than a service technician trained by the Manufacturers to perform service repairs.

Contents

Specifications	page 3
Installation	page 4
Features Diagram	page 6
Using your microwave oven	page 7
Operating instructions	page 8
Planning & Cooking	page 9
Cleaning and Maintenance	page 12-16
Helpful Hints	page 17
Microwave Cooking Terms and Techniques	page 18
Questions and Answers	page 19
If the oven does not work	page 20
Zanussi Guarantee Conditions	page 21
Zanussi 5 Year Cover	page 22

Important: the installation of the oven and connection to the electricity supply must always be done by competent installers and to standards and regulations currently in force.

Specifications

ME1205

AC Line Voltage	240V/50Hz
AC Power Required	1470W
Output Power	650W (litre water load)
uW Frequency	2450 Mhz
Exterior Dimensions	560mm (W) × 395mm (H) × 439mm (D)
Oven Cavity	370mm (W) × 270mm (H) × 370mm (D)
Cooking Uniformity	Wave Stirrer (Motor driven)
Weight	Approx 28 kg

Installation

Please note: This microwave cooker has been designed to be used in a domestic household. Therefore the guarantee supplied with this appliance may be invalidated if it has been used for a commercial or catering application.

After unpacking, ensure that all packing materials have been removed from the oven cavity.

Positioning

This oven is free-standing and can be placed wherever you choose within reach of a power outlet. Ensure that the surface on which the oven is to stand is level and is capable of withstanding the weight. To ensure that the oven has adequate ventilation, there must be at least 2.5cm/1 inch of clearance at the top, 4cm/1½ inches at the back and a total of 15cm/6 inches side clearance.

The unit must not be installed in any area where heat and steam are generated, for example, next to a conventional oven.

NOTE* Do not store cookbooks or the instruction book inside or underneath the oven. Do not place tea towels or utensils over the cooling vents.

Electrical Connection

***THIS APPLIANCE MUST BE EARTHED**

For your convenience and safety, your new Zanussi microwave oven comes ready fitted with a moulded flex and plug. All you need to do is push the plug into a 13 amp power socket and switch on. If for any reason you need to replace this plug with one of your own, you will find the wires inside the flex are colour coded as follows:

GREEN AND YELLOW - EARTH
BLUE - NEUTRAL
BROWN - LIVE

If you fit your own plug, the colours of the wires in the mains lead of your appliance may not correspond with the markings identifying the terminals in your plug. If this is the case proceed as follows:

Connect the green and yellow (earth) wire to the terminal in the plug which is marked with the letter 'E' or the earth symbol \perp or coloured either green or green and yellow.

Connect the blue (neutral) wire to the terminal in the plug which is marked with the letter 'N' or coloured black. Connect the brown (live) wire to the terminal which is marked with the letter 'L' or coloured red.

The cut off plug should be disposed of to avoid the risk of shock from the plug being inserted into a 13 amp socket elsewhere in the house.

Fuses

The appliance's moulded-on plug is supplied fitted with a 13 amp BS1362 fuse. If this fuse blows you can replace it in the following way:

Remove the plug from the power socket and use a small screwdriver to lever out the red plastic fuse carrier located between the plug's prongs, together with the old fuse. Fit in a new 13 amp fuse and clip it back into the plug. Make sure your new fuse is 'ASTA' approved and complies with BS1362. If the carrier is damaged you can get a new one from your local Zanussi Service Agent, the details of which can be obtained by looking under 'Z' in your telephone directory.

Safety

★ Check that the supply flex and any other wiring is positioned in such a way that when the microwave oven is operating its temperature at any point is less than 50 degrees C above the ambient temperature of the room.

★ Never remove the rear panel of the oven to gain access to the terminal board. If an extension is required it should be made using the standardised plug and the external cable, which should be capable of carrying the expected load.

★ Check that the fuse and domestic installation are suitable to carry the electric load of this appliance (see rating plate at the back of the oven).

★ Check that the appliance is properly earthed according to existing rules and regulations.

This appliance meets the requirements laid down in the EEC Directive No 76/889 and amendment 82/499 relating to the suppression of radio and TV interference.

Features Diagram

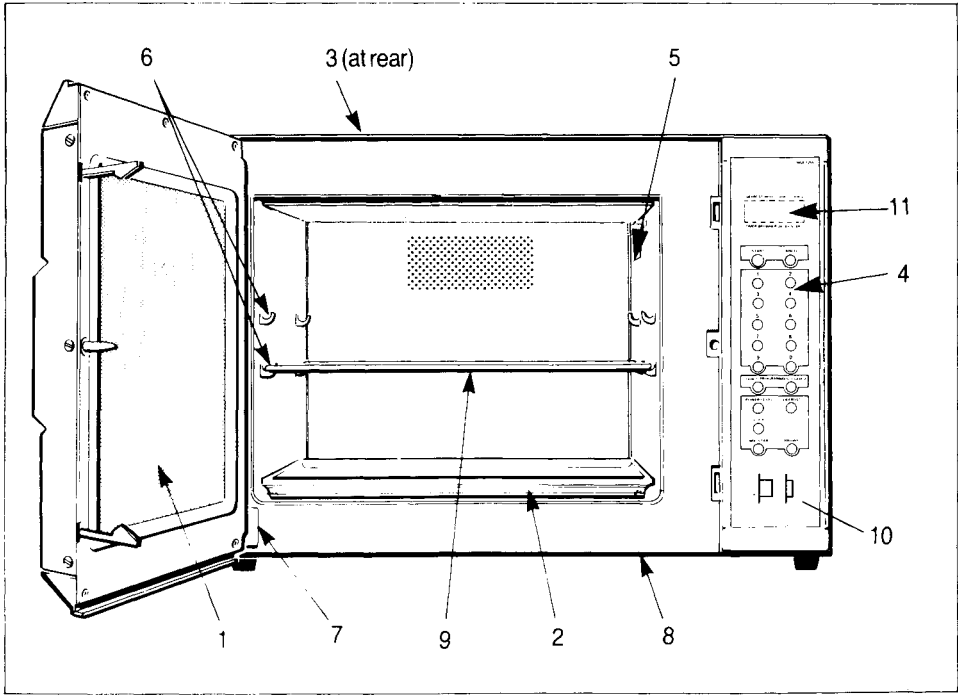

Becoming familiar with the working part of your microwave oven will help you understand the important operating information on the following pages.

- 1. SEE THROUGH DOOR** lets you check the cooking without interrupting it.
- 2. REMOVABLE TRAY** makes cleaning easy. The tray should always be kept in place when using the oven.
- 3. VENTS** should be kept unobstructed. Leave at least 2 inches of clear space above the oven for air circulation.
- 4. CONTROL PANEL.**
- 5. OVEN LIGHT.**
- 6. SHELF SUPPORTS.**
- 7. RATING PLATE** located on the face of the oven front adjacent to the hinge.
- 8. AIR INTAKE AREA.**
- 9. METAL SHELF.**
- 10. POWER SWITCH.**
- 11. DIGITAL DISPLAY**

Using your microwave oven

Before using the microwave oven for the first time, ensure that all packaging materials have been removed from both the outside and inside of the oven. Wipe out the inside of the oven with a damp cloth. Check that the door seal and sealing surfaces are not broken or cracked, that the door is not warped and that the hinges and latches are not broken or loosened. If you do find any damage, contact your local Zanussi Network Service Centre.

Microwave cooking is very versatile. It enables you to cook, reheat, roast, simmer, hold-warm and even defrost with speed and convenience.

As microwaving is such a new and fast way of cooking, you should be able to be more adventurous as you become more familiar with this method of cooking.

To begin with something easy, heat a cup of coffee in a mug for two minutes, but open the door at any time and check if the coffee is as hot as you like it. Next try heating leftovers on a plate. An average serving takes about 2-3 minutes on power level 8. Look for steam or test the food to see if it is ready.

You can open the door at any stage. If additional time is needed, add it gradually. It is always better to under estimate the cooking time than over estimate.

Every recipe in the cookbook gives the approximate cooking time. Because of factors such as food temperature, dish shape, arrangement of food and density of food it is difficult to give a precise time.

Always start with a shorter time and add time if needed.

The microwave oven cooks much faster than conventional ovens. It is wise to take special care when you are cooking something for which specific timings have not been recommended. This applies particularly when reheating foods. Always watch the cooking or heating of the food and give it a short cooking time, adding more until you have the required results. You will soon learn the correct timings for cooking or heating your favourite foods. It is important to remember that it is possible to burn foods if they are cooked for too long, but the burning will occur inside the food first and will only become apparent by smell.

The oven must not be used without the glass tray in position.

The door seal is designed to prevent leakage of microwave energy during cooking. Occasionally moisture may appear around the oven door, this is normal.

Please remember that the cookbook is only a guide.

Operating Instructions

The controls

1. POWER SWITCH. Push the button located at the bottom of the control panel to turn on the microwave oven. The light inside the oven will come on and the control panel will be ready for you to programme. When you've finished cooking, push the button again to turn the oven off. This button does not start the cooking process.

2. START. Press the START button when you have programmed your oven, unless you are using the delay start function.

3. CANCEL. This button is used to cancel any errors in programming. Everything is cancelled except the clock.

4. COOK 1. This button allows you to cook automatically at high (100%) power or any of 9 other power levels available. It is also used in conjunction with the number buttons to set the cooking time.

5. COOK 2. This button is used when you wish to cook the food firstly at one power level and then at another. Two sets of cooking times and power levels can be programmed at once without any interruption to the cooking process or without stopping the microwave oven.

6. POWER LEVEL. The oven will automatically cook at High power (100%). If you wish to opt for any of the other 9 power levels, touch the POWER LEVEL button then the number button for the level you wish to select. For example, if you wish to cook at Medium (50%), touch POWER LEVEL then '5'. For Low (30%), touch POWER LEVEL and then '3'. There is no need to press the 0 button.

7. DEFROST. This button is used for either defrosting or cooking at Low (30%) power. It is used in conjunction with the number pads as you programme the recommended time for thawing frozen foods.

The DEFROST HOLD feature automatically assures you of more complete defrosting when you are planning to cook immediately after defrosting and have programmed the cooking time. After the defrosting time is completed, the Defrost Hold indicator light will begin flashing if the COOK 1 button and a time is set to automatically take place. There will be a holding time equal to the defrosting time before the cooking actually begins.

8. CLOCK. Use the CLOCK button when setting the time of day or when you want to check the time while you're cooking.

9. TIME/START. You can use the TIME/START button as a reminder for many kitchen chores. The TIME/START lets you set the controls to turn the oven on automatically at any time of the day, whether you are at home or not.

10. NUMBER BUTTONS. These numbers are used for different functions:

- a) To set power levels (see POWER LEVEL button).
- b) To set cooking times when using the various function buttons.
- c) To set CLOCK, Start Time and Timer functions.

The maximum length of time you can set for any function is 99 minutes and 99 seconds. (99:99).

11. THE DISPLAY WINDOW. Individual light indicators flash to show when the oven is in any of the functions: Defrost, Hold, Programme 1, Programme 2, Timer, or Start Time.

The digital numbers will show what power level you have set, the time you have set, as well as the cooking time remaining after the oven starts. It will show the counting of any holding time.

Operating the controls

These controls are easy to operate. Just practice by following the step by step instructions below and you'll soon become familiar with the operation.

Don't be afraid to experiment. Each time you give the oven an instruction by touching a button, it will 'bleep' in response.

PLEASE REMEMBER NEVER TO PRESS THE 'START' BUTTON WHEN THERE IS NO FOOD IN THE OVEN, SO PLACE A CUP OF WATER IN THE OVEN WHILST YOU'RE PRACTICING.

Any mistakes in programming can be cancelled by pressing the CANCEL button.

When you are practicing, you can use the CANCEL button to clear the programmes if you don't want to wait for the time to elapse. This CANCEL button can be used whenever you wish to finish one cooking task and move to another.

Oven Shelf

Your new microwave oven includes a removable metal shelf to increase the capacity of the oven. The shelf is designed specifically for use in your oven and will not interfere with the correct distribution of microwaves. No other shelf should be used.

The shelf can be used in either of two positions. You should choose the position that suits the sizes of dishes being used. The shelf must be removed when it is not in use.

The shelf is used for

1. Cooking or reheating several items of food at one time in the oven.
2. Increasing the oven capacity so that complete oven meals can be cooked in a simple one or two step operation. See 'Planning and Cooking' for hints on how to benefit from your oven shelf.

3. The metal shelf should only be used when employing both cooking levels. On no account may it be used when microwave cooking on one level only.

NOTE: Under some circumstances the metal shelf will become hot. Oven gloves should be used if the shelf is to be handled during or just after cooking.

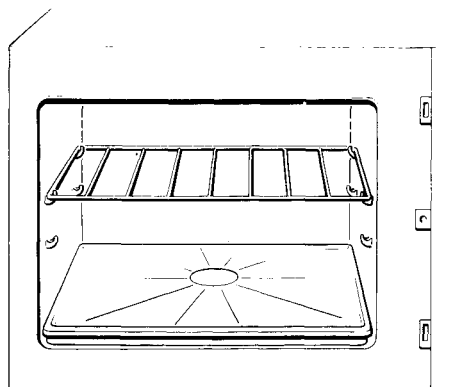

SHELF IN UPPER POSITION

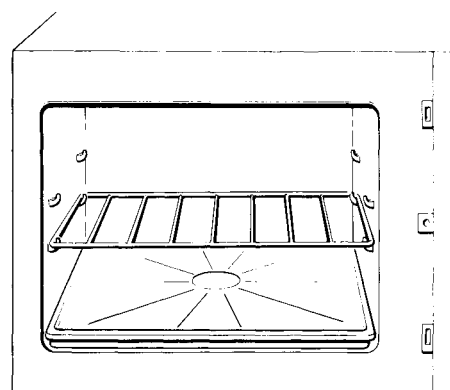

SHELF IN LOWER POSITION

The Display Window

The display window has three basic functions:

1. It shows what you are programming the oven to do
2. It shows what the oven is actually doing while cooking
3. It gives you the time of day

Digital timing display

A flashing colon will appear in the display window whenever the microwave is plugged in or the electric power comes on after being off. Once you have set the clock, the time of day will appear in the window when the POWER switch is off. When this is pushed in, four zeros will appear.

When setting a cooking time, the numbers will move across the screen from right to left, as you touch the number buttons.

Function indicators

Small bars of light will appear in the display window.

Defrost: Flashes when you touch the DEFROST button. Remains lighted during the defrost operations.

Hold: Lights if you programme a COOK 1 operation immediately following defrost, or if you programme a temperature of 60° or above. This remains lighted until the oven goes in Defrost Hold, when it flashes until the hold cycle is finished. Also flashes when a Start Time has been set and the oven is waiting to begin cooking.

Cook 1: Flashes when you touch the COOK 1 button or set a cooking time. Remains lighted until the oven begins the Clock 1 cycle, then flashes until that cycle is completed.

Cook 2: Flashes when you touch the COOK 2 button. Remains lighted until the oven goes into the second cooking cycle, then flashes until that cycle is finished.

Delay Start: Flashes when you touch the TIME/START button. Remains lighted until the oven begins cooking.

Power levels

When you touch the POWER LEVEL button the letter 'H' will show in the display. This indicates that the oven is automatically set to cook at High (100%) power level.

When you change the power level the number which you programme will be shown on the display. For example, if you change the power level to 50% by touching the number 5, the number 50 will be displayed. To check a power level during a cook cycle, simply touch the POWER LEVEL button to recall the information for 3 seconds. The power level can be changed at any time during the cycle. Simply touch the POWER LEVEL button, and programme revised power level.

The clock







The digital 24 hour clock operates even when the oven is not in use. The clock should always be set and running. While most timing can be done if the clock is not set, the TIME/START feature cannot. The oven should be turned off by the switch button before setting the clock.

To recall the time of day during cooking, simply touch the CLOCK button and the correct time of day will appear for 3 seconds on the display window.

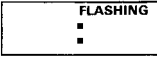
If no time is set, or the wrong time, (e.g. 33:00), a flashing colon appears in the display window. If the oven is unplugged or the power is off, the time will be lost. When power is restored, the flashing colon will appear to remind you to reset the clock. If an incorrect time appears, touch the CLOCK button.

To set the clock to the correct time of day.

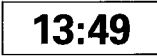
- Suppose you wish to set the clock to 1:49pm (13:49).

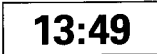



PROCEDURE	BUTTON ORDER	DISPLAY
1: Touch the CLOCK button	CLOCK 	
2: Touch the numbers 1, 3, 4 and 9 buttons	    <small>PRESS</small> <small>Once</small> <small>Once</small> <small>Once</small> <small>Once</small>	
3: Touch the START button	<small>Start</small> 	

Setting the cook programmes

To cook at Full Power:

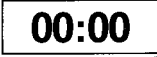
As the oven automatically cooks at High level you would normally only need to programme the cooking times required.

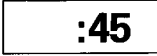
- Suppose you wish to set the cooking time for 45 seconds at full power.

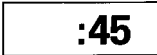
PROCEDURE	BUTTON ORDER	DISPLAY
1: Push in the switch button		
2: Touch the numbers 4 and 5 buttons	  <small>PRESS</small> <small>Once</small> <small>Once</small>	
3: Touch the START button	<small>Start</small> 	







The cooking time will count down to zero at the end of all cooking cycles. When the timer reaches zero, the indicators will go out and you will hear four 'beeps'. Microwave energy will stop and the time of day will reappear on the display. After the POWER switch button is released.

If the door is opened during the cooking process, the cooking time in the readout automatically stops. The cooking time starts to count down again when the door is closed as the START button is touched.

If you have touched START and the oven is operating, you can double-check the cooking function times you have set by touching the retrospective function button EXCEPT for any cooking function already in operation or completed. This information will appear on the display window for 3 seconds, then the display will go back to whatever cooking function the oven is in.

Cooking at a different power level











- Suppose you wish to set the cooking time for 20 minutes at 70% power level.

PROCEDURE	BUTTON ORDER	DISPLAY
1: Push in the switch button	PRESS 	00:00
2: Touch the number 2 button once, and the number 3 button three times	PRESS  Once  Three Times	20:00
3: Touch the POWER LEVEL button then the number 7 button	Power level  	70
4: Touch the START button	Start 	20:00

Using COOK 2 to give two different power levels in one cooking programme.

Some recipes require food to be cooked at one power level for a period of time, and a different power level for the remaining period. You can programme the oven to do this automatically.











- Suppose you wish to programme the oven to cook at High (100%) for 8 minutes, and Medium (50%) for 70 minutes. This would give a total cooking time of 1 hour 18 minutes.

PROCEDURE	BUTTON ORDER	DISPLAY
1: Push in the switch button	PRESS 	00:00
2: Touch COOK 1, then number 8 button, then 0 button twice	COOK 1    PRESS Once Once Twice	8:00
3: Touch COOK 2, then number 7 button, then 0 button three times	COOK 2    PRESS Once Once Three Times	70:00
4: Set the new power level. Touch POWER LEVEL, then number 5 button	Power level  	50
5: Touch the START button	Start  Once	8:00

Using the TIME/START facility

This enables you to programme the oven to turn on at any time you choose. PLEASE NOTE that if the time/start feature does not work, it is because the clock is not set and running.

- Suppose you want the oven to turn on automatically at 17.30 hours (5.30pm) and cook the food for 35 minutes.





PROCEDURE	BUTTON ORDER	DISPLAY
1: Push in the switch button	PRESS 	00:00
2: Touch the TIME/START button	PRESS  Time/Start	:
3: Touch the numbers 1, 7, 3 and 0 buttons	 1  7  3  0 PRESS Once Once Once Once	17:30
4: Touch the COOK 1 button and number 3 button once, number 5 button once and number 0 button twice	 COOK 1  3  5  0 PRESS Once Once Once Twice	35:00
5: Touch the START button	PRESS  Start	TIME OF DAY

The 'Hold' indicator light will flash and the time of day will show until it is time for the microwave to start cooking. If the door is opened before cooking begins, touch the START button again after the door is closed. If this procedure is not carried out, cooking will not start.

Setting the Timer

This facility can be used as a handy timer for many domestic chores. The timer does not control the oven in any way and can only be used when the power switch is not turned on, i.e. when the oven is not being used for cooking. When the timer reaches zero it gives 4 short 'bleeps'.

- Suppose you wish to set the timer to 38 seconds.

PROCEDURE	BUTTON ORDER	DISPLAY
1: Touch the TIME/START button	PRESS  Time/Start	00:00
2: Touch the number 3 button and the number 8 button	 3  8 PRESS Once Once	:38
3: Touch the START button	PRESS  Start	:38

The set time may be changed by touching CANCEL once, then TIME/START and the new time. Then touch START.

When the time has run out, the display will show 00:00. To restore the clock, touch either CANCEL or CLOCK.







Using the defrost facility

Food is automatically defrosted at a low setting (30%), and you should never attempt to defrost it at a higher power.

The oven automatically cycles on and off which allows the heat to equalize throughout the food. At higher power levels, you will find that before the food is completely defrosted on the inside, the outer edges may begin cooking.

It is important to thoroughly defrost food before cooking.

- Suppose you wish to defrost for six minutes.

PROCEDURE	BUTTON ORDER	DISPLAY
1: Push in the switch button	 PRESS	00:00
2: Touch DEFROST then number 6 button once and number 0 button twice	 DEFROST PRESS  6 Once  0 Once Twice	6:00
3: Touch the START button	 Start PRESS  Once	6:00

Defrost hold









When using the DEFROST button, you can programme the oven to automatically start cooking after the defrost time is completed.

There will be an automatic holding time or standing time before the cooking actually starts. The Defrost Hold indicator will flash while this holding time is in progress.

During Defrost Hold, the display will count down to equal the original defrost time.

During the holding time, temperatures even out throughout the food to give complete defrosting.

- Suppose you wish to defrost food for 2 minutes and automatically cook at on High (100%) for 20 seconds.

PROCEDURE	BUTTON ORDER	DISPLAY
1: Push in the switch button	 PRESS	00:00
2: Touch the DEFROST button, then number 2 button once and the number 0 button twice	 DEFROST PRESS  2 Once  0 Once Twice	2:00
3: Touch COOK 1, then number 2 button once and number 0 button once	 COOK 1 PRESS  2 Once  0 Once	:20
4: Touch the START button	 Start PRESS  Once	2:00

PLEASE NOTE: If the door is opened during the Defrost Hold period, the remaining defrost hold period is cancelled, and on closing the door and touching the START button, the COOK 1 period will start immediately.

Planning and cooking

. . . multi foods and complete oven meals in the microwave oven

When cooking several food items or complete oven meals, the location of each item is important. When combining cooking of several dishes, those that require the longest cooking times are placed on the shelf whilst those requiring shorter cooking or heating times are placed on the glass tray. This is because the microwaves first start cooking the food at the top of the oven.

Remember that as the amount of food placed in the oven is increased the cooking times must also be increased. Therefore, complete oven meals will require a longer cooking time than the cooking of one food item.

To get a general idea of how much time a complete meal will require, add up the amount of time required for each food, if cooked separately, and this will be the approximate cooking time required. In most cases, the cooking of a complete meal at one time will not save significant cooking times. However, the convenience of being able to place all the food in the oven at the same time will make microwave cooking more convenient.

When planning oven meals, take into consideration the types of food and how quickly they cook in the oven. It may be necessary for you to check the food during cooking, removing some food ahead of time or allowing some food to cook for a longer period of time. In most cases you can place several items of food in the microwave oven at the same time.

However, some food that takes longer to cook should be put in the oven earlier, and faster cooking food, such as rolls should be put in the oven later in the cooking period. Placing food directly over each other on the top and bottom shelves will slow down cooking of the food on the bottom glass tray.

Place small cups or dishes carefully on the shelf so they do not tip.

Cleaning and maintenance

Microwave oven cleaning

***THE ELECTRICITY SUPPLY SHOULD BE DISCONNECTED BY REMOVING THE PLUG FROM THE SOCKET BEFORE CLEANING.**

It is important to wipe up all spillages as these can affect the cooking time. The spillages absorb microwave energy and prolong the cooking time.

To keep the oven free from grease and soil build-up, it should be cleaned with a damp cloth after use. A soft nail brush can be used to remove stubborn stains.

Odours can be eliminated from the inside of the oven by boiling a solution of one cup of water and several tablespoons of lemon juice in the cavity. We would also recommend occasionally wiping the oven interior with a sterilising fluid e.g. Milton, in the interest of hygiene.

Only use a mild detergent, water and a soft, clean cloth to clean the oven face and other surfaces, and polish dry with a soft cloth or paper towelling. Do not use aerosol, caustic or abrasive cleaners, or scrape the interior surface with knives or other utensils. This could cause the enamel paint to come off, exposing the metal underneath. Any exposed metal could cause sparking or arcing, and further damage to the oven.

Wipe out crumbs that fall between the door and the frame with a damp cloth. It is important that the door seal area is kept clean. If there is a greasy film on the oven door, a small amount of vinegar water can be used to remove the grease. Rinse with cold water and polish dry with a soft cloth or paper towelling.

The light bulb

If the light bulb should burn out, it is very easy to replace.

1. Unplug the microwave oven from the mains supply.
2. Remove the smaller of the two access covers on the outside back of the oven by removing the screw (where fitted) or pressing the bottom centre upwards to release the clip. (The access cover is also an air vent).
3. Take out the burned out light bulb and replace with a 40W round bulb with E14 screw cap.
4. Replace the access cover and fixing screw (where fitted). This cover must be in place before operating the oven.
5. Plug in the microwave oven and it is ready for use again.

Helpful hints

★ Dinner rolls can be heated in a basket lined with a cloth or paper napkin and taken to the table. Ensure you only heat for a short time as the bread can become brittle with overcooking.

★ When you have extra time, make cake toppings and fillings and store in the refrigerator. When required just heat for 10-20 seconds and spread on cake.

★ Freezer wrapping can be easily removed from frozen meat if heated in the microwave oven until the wrapper looks moist.

★ Commercially packaged frozen fruit can be placed in a glass dish and defrosted in a few minutes for serving. Put package or carton in glass dish to hold the melted juice. Open carton and serve fruit. If package has metal ends, remove before heating.

★ Try cooking chicken halves, whole hams, roasts, etc. for a short time in the microwave cooker before placing them on the rotisserie or grilling over the outdoor barbecue. This will avoid excessive exterior charring.

★ Bread may be taken from the freezer and quickly defrosted in your microwave oven. Open bag and be sure to remove metal ties. Heat until you can see a drop or two of moisture inside the wrapping.

★ Melt butter or chocolate, soften butter for creaming or for spreading on bread or toast.

★ If a small amount of food is heated in the microwave oven, such as a tablespoon of butter, a square of chocolate or a small potato, place a cup of water in the cooker to increase the cooking load.

★ Wooden spoons may be left in sauces etc. for up to 5 minutes.

★ Cheese from the refrigerator can be brought back to room temperature in a matter of seconds in your oven.

★ Microwave oranges for 10-15 seconds for easy peeling.

Microwave cooking terms and techniques

Stirring

With food such as casseroles, sauces and soups it is necessary to stir the ingredients during the cooking time so that the heat is evenly distributed.

Arrangement of food

To ensure even cooking of food it is best to arrange it so that the thinner sections are placed towards the centre of the dish, and the thicker, more dense parts of the food are on the outside. For example, if cooking chicken drumsticks, the joint should be arranged with the plump end pointing out from the centre of the dish.

Turning food

Also to ensure even cooking, dense items such as hams, roasts or whole poultry should be turned at least once during the cooking programme. When using individual dishes it is advisable at some time during the cooking programme to re-arrange the dishes so that they will all be ready at the same time.

Standing time

Microwaves only penetrate food to a depth of 4 cm/1½ inches, so dense food items are best left to stand for a short period of time once the microwave cooking is complete. The heat inside the food will penetrate to the centre and ensure that it is completely cooked. Standing time can take place either on the kitchen surface or in the microwave with the power off. The food is covered, often with foil, and left so that the heat can transfer evenly throughout the food. The denser the food, the longer the standing time.

Shape of food

Always aim for uniform shapes to aid the even cooking of food. This is especially relevant when cooking joints of meat and it is advisable to bone and roll joints such as legs of lamb before cooking.

Covering

There are several types of covering and they are all used for different purposes. Plastic film or glass lids help to hold in steam and therefore retain moisture so the food can cook more quickly. Paper towels or napkins can be used as loose covers in order to prevent spitting and also to absorb moisture. Wax paper can also be used.

Cookware

The range of cooking utensils that can be used in the microwave is wide. There are many excellent varieties of cookware specially manufactured for use in the microwave/freezer. Also much of the conventional kitchen equipment is quite suitable. The basic rule to remember is not to use anything made of metal or with any metal parts. This includes screws, handles, metallic designs on plates, foil dishes, and metal ties on food bags from the freezer. Some plastics such as melamine or urethane may be warped or cracked in the microwave. The most suitable dishes are made of china, pottery, ovenproof glass or paper. For further information see your microwave cook book. If you have any doubts about the suitability of a particular dish, carry out a simple test by placing a glass half filled with water next to the dish to be tested in the oven. Heat for 30 seconds. If the dish feels warm, it should not be used.

Questions and Answers

Q Does it harm the oven if it is accidentally operated with no food in it?

A Severe damage can occur if the oven is turned on when it is empty.

Q Is eating food cooked in a microwave oven harmful?

A Microwaves are simply a source of heat energy just like gas and electricity. All three produce cooking in the food itself. Therefore food cooked in a microwave oven is not harmful to eat.

Q Why do I have moisture in the microwave oven after cooking?

A The moisture on the inside of your microwave oven is normal and nothing to worry about. It is caused by the steam from the cooking food hitting a cool oven surface. Wipe excess moisture from the inside of the oven after each use.

Q What causes the oven interior light to dim when using Variable Power?

A This is normal and indicates that the oven is operating and cycling normally.

Q Foods cooked in a microwave oven seem to cool off faster than conventionally cooked foods. Why is that?

A Often the dish used to store foods in the refrigerator is then used for heating the food in the microwave oven. In this case, the cold dish absorbs heat from the food. It may be necessary to heat the food for an additional time.

If the oven does not turn on

- ★ Check that the appliance is connected correctly.
- ★ Check that the plug is firmly connected to the wall socket and that the socket is switched on. Check the power supply by plugging in another appliance.
- ★ Replace the fuse in the plug with another of the appropriate rating.
- ★ Check that the fuse in the fuse box is intact.
- ★ Ensure that you have pressed 'Start' to commence cooking, and that the door is firmly closed.
- ★ If the cooking results are not satisfactory, ensure that you have programmed the oven correctly.
- ★ Check that the food is not covered with excessive foil and you have not used a metal lid. Also check that the air vents are not obstructed.
- ★ If the oven light does not operate, check the fuse in the plug and the oven light bulb (see Cleaning & Maintenance).
- ★ If after all these checks the appliance still does not work, call your local Zanussi Network Service Centre, the details of which can be found in your local telephone directory under 'Z'.

NEVER ATTEMPT TO REMOVE THE REAR PANEL OF THE OVEN OR TAMPER WITH THE OVEN IN ANY WAY.

- ★ Please note that it will be necessary to provide proof of purchase for any in-guarantee service calls.

Peace of mind for twelve months

Zanussi standard guarantee conditions

This guarantee is in addition to your statutory and other legal rights which will not be excluded or in any way diminished by the return of this guarantee card. We, Zanussi Limited, undertake that if, within twelve months of the date of the purchase, this ZANUSSI appliance or any part thereof is proved to be defective by reason only of faulty workmanship or materials, we will, at our option, repair or replace the same FREE OF ANY CHARGE for labour; materials or carriage on condition that:

- The appliance has been correctly installed and used only on the electricity supply stated on the rating plate.
- The appliance has been used for normal domestic purposes only, and in accordance with the manufacturer's operating and maintenance instructions.
- The appliance has not been serviced, maintained, repaired, taken apart or tampered with by any person not authorised by us.
- The appliance is still in the possession of the original purchaser.

All service work under this guarantee must be undertaken by a Zanussi Network Service Centre.

Any appliance or defective part replaced shall become our property.

Exclusions

This guarantee does not cover:

- Damage or calls resulting from transportation, improper use or neglect, the replacement of any light bulbs or removable parts of glass or plastic.
- Cost incurred for calls to put right machines improperly installed or calls to machines outside the UK and the Republic of Ireland.
- Appliances found to be in use within a commercial environment, plus those which are the subject of rental agreements.

Or five years

Zanussi 5 Year Cover Conditions

(See enclosed leaflet)

For a once-only payment you can extend your Standard Guarantee, all the conditions and exclusions of which apply.

1. Products supplied as 'seconds', refurbished, damaged or shop-soiled are not eligible for Zanussi cover.
2. The issue of a cover does NOT by virtue of our having done so, nullify the exclusions.
3. The Engineer will need to check the details of your Cover card and will make a charge for his services if it is not presented to him at the time of his call.
4. The date of purchase, or the date of initial payment (deposit) of the appliance will be deemed the date of commencement of cover.
5. Covers issued are not refundable or transferable.
6. Change of address:
Zanussi Cover Card is valid throughout UK, including Isle of Man, Channel Islands, Northern Ireland and Republic of Ireland and does not require amending. Advice in writing, quoting the 'Cover' Card number is necessary to enable correction of our records.



ZANUSSI

The Appliance of Science